

HD 7000

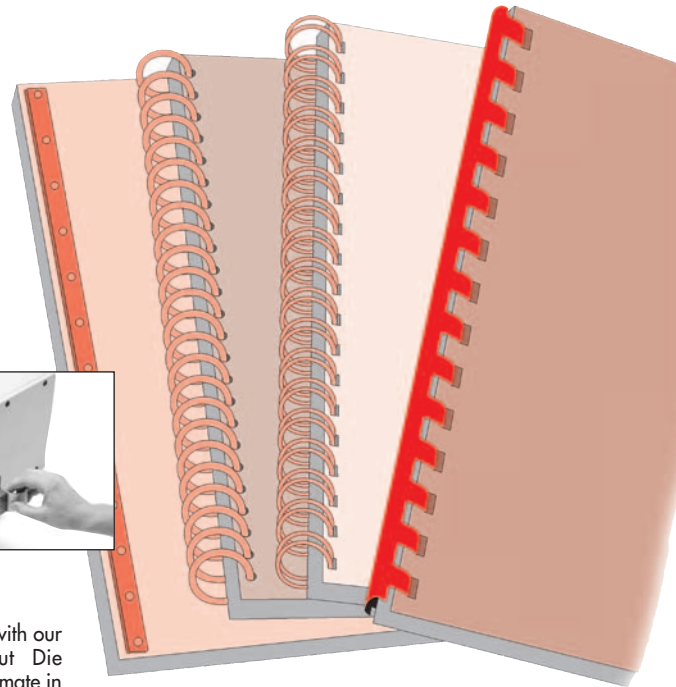

New for the HD 7000, this photo shows our ingenious die pin retainer system. Coupled with our Quick Change Slide Out Die System you will have the ultimate in versatility and productivity. Also shown is the adjustable punching margin control for the comb punch. Patent# 5,771,768 & 6,047,623

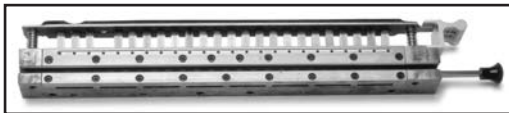

UL & CE Approved

14" HEAVY DUTY DELUXE OPEN END PUNCH

FEATURES *(See Specifications on Back)*

- Patented Anti-Jam Feature. Our New Over-load Detection Feature Triggers an Auto-Reversing Function to Eliminate Jamming in the Punch
- Patented "QCDS", Quick Change Die System. No Tools, Nothing to Take Apart
- The HD 7000 Has More Than 20 Interchangeable Dies Available. 12 Hole Patterns are Standard.
- Comes With Your Choice of a Standard Die. (Ask for Details)
- 14" Open Ended Punching, Allows for Wider Applications
- 90 Cycles Per Minute
- Rated up to 40 Sheets or up to 80 Pages of 20 lb. bond paper. The Number of Sheets Depends on the Paper Weight and Punch Pattern Used. (15,000 to 18,000 SPH)
- Pre-set Paper Stop Guide for Easy Setup
- All Punch Pins Easily Disengaged
- Easy, "Paper to Pin" Sight Alignment, for Balanced Hole to Edge Margins on Odd-Sized Applications
- Smooth, Quiet, Power on Demand Operation
- Use Foot Pedal, Versa Switch, or Palm Switch
- 1 Year Limited Warranty
- All Metal Fabrication
- Now Includes Commercial Chip Tray

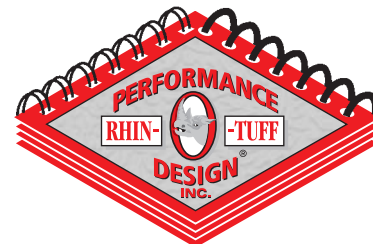

THE ULTIMATE IN:
*Quality Paper Punching and Book Binding
 Equipment at Affordable Prices*

www.RHIN-O-TUFF.com



HD-4470

Comb Opener Module

✓ NOW 14 Inches



HD-4470 shown mounted on the OD-4012 Electric Punch

14" (356MM) COMB OPENER MODULE

FEATURES

- ✓ Will Bind Up To 2" (51MM) thick and 14" (356MM) Wide.
- ✓ The Opener Has an Adjustable Ring Opener Control for Exact Book Placement.
- ✓ Optional Interface Kit. Use as a stand alone or in combination with any Rhin-O-Tuff vertical punch and obtain maximum binding and punching throughput.
- ✓ One year limited factory warranty.
- ✓ Fast, accurate and built with Rhin-O-Tuff reliability.

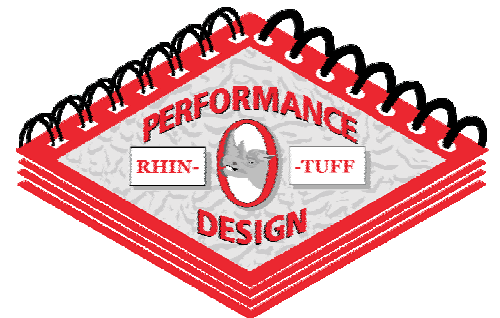

THE ULTIMATE IN:

Quality Paper Punching
and Book Binding Equipment
at Affordable Prices

Call **1-800-390-5782** For a Dealer Near You or Visit
www.RHIN-O-TUFF.com

HD-4470

MACHINE SPECIFICATIONS

ELECTRICAL REQUIREMENTS			WEIGHT		DIMENSIONS		
VOLTS AC	AMPS	Hz	MACHINE	SHIPPING	HEIGHT	WIDTH	DEPTH
-	-	-	16 lbs.	23 lbs.	12"	19"	14"

12 Standard Punch Die Patterns Available. All Other Patterns Available Upon Request.

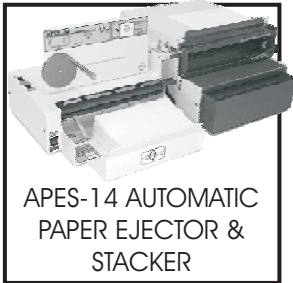

APES-14 AUTOMATIC PAPER EJECTOR & STACKER



HD-7700H HORIZONTAL PUNCH

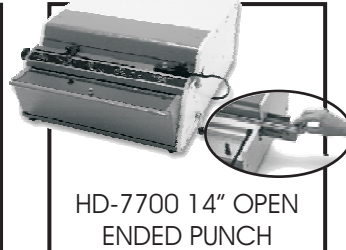

HD-7700 14" OPEN ENDED PUNCH

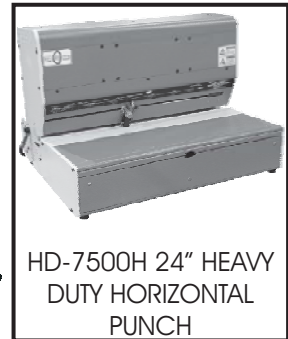

HD-7500H 24" HEAVY DUTY HORIZONTAL PUNCH

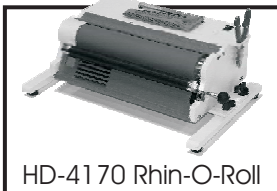

HD-4170 Rhin-O-Roll



PC-248 MANUAL PUNCH AND ELECTRIC COILING SYSTEM

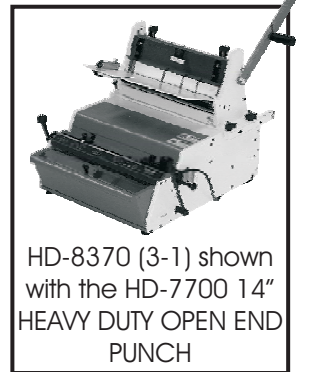

HD-8370 (3-1) shown with the HD-7700 14" HEAVY DUTY OPEN END PUNCH



HD-8000 WIRE CLOSER



HD-4170 12" COIL INSERTER mounted on the OD-4012 11" ELECTRIC PUNCH



EWC-14 14" All Pitch (Shown) And EWC-24 24" All Pitch Flat Bar Wire Closer



HC-8024 24" WIRE CLOSER



HD-8000 shown with the OD-4012 11" ELECTRIC PUNCH



PAL-M MANUAL Piks-A-Lift

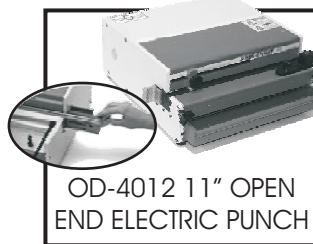

OD-4012 11" OPEN END ELECTRIC PUNCH



HD-7000 14" HEAVY DUTY OPEN END PUNCH



HD-e4100 Electric ECON-O-ROLL Coil Inserter



PAL-14 "Piks-A-Lift" mounted on the OD-4012 ELECTRIC PUNCH

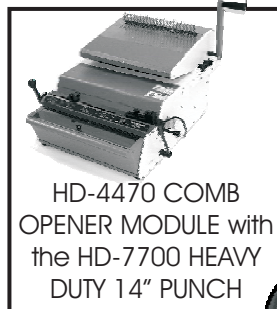

HD-4470 COMB OPENER MODULE with the HD-7700 HEAVY DUTY 14" PUNCH



KF-50 KRIMP-Fast PLASTIC COIL CRIMPER

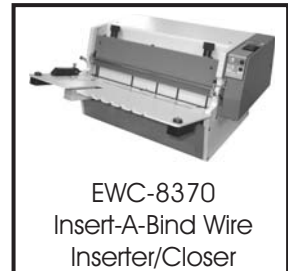

EWC-8370 Insert-A-Bind Wire Inserter/Closer



Call 1-800-390-5782
For a Dealer Near You or Visit

www.RHIN-O-TUFF.com

V0906